

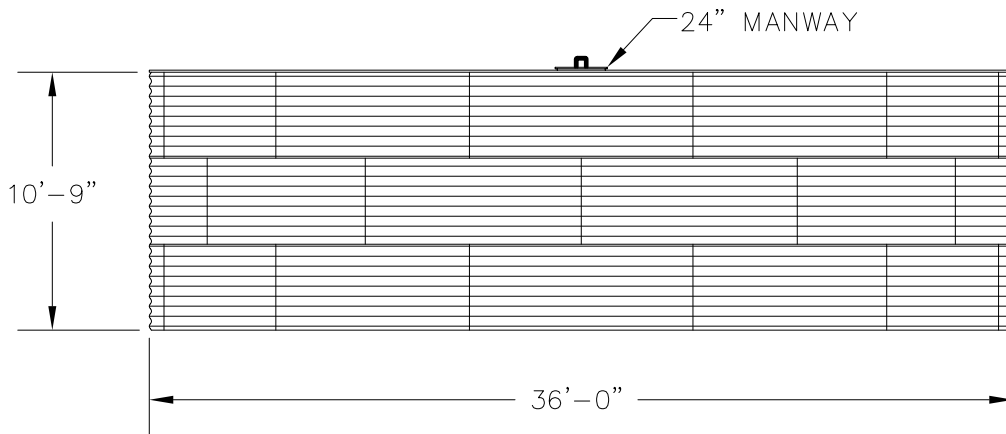

PLAN



ELEVATION

 WATER STORAGE TANKS, INC. 1-800-463-1898 www.corgaltanks.com		BY	DATE	TITLE		
	DWN	RU	7/30/08	MODEL 3603-WT-SAP-CFR		
	CKD	JH	7/30/08	CORGAL STEEL WATER STORAGE TANK		
	ENG	JH	7/30/08	NOMINAL CAPACITY - 76,000 GALLONS (U.S.)	DWG. NO.	REV. NO.
THE DRAWING DEPICTED ON THIS PRINT AND THE INFORMATION CONTAINED HEREIN ARE PROPRIETARY TO Water Storage Tanks, Inc. AND SHALL NOT BE USED IN WHOLE OR PART WITHOUT THE WRITTEN CONSENT OF Water Storage Tanks, Inc.				3603-WT-SAP-CFR	A	
		SIZE	SCALE	SHEET	OF	
		A	1/8"=1'-0"	1	1	1